

## PERFORATIONS

A variety of perforation patterns are available to meet your project's specific requirements. These offer acoustic benefits, such as sound absorbing, augmented with dispersal backing, which can achieve NRC values ranging from .50 — .95. Noise reduction may be achieved by perforating the surface with the following patterns and adding acoustic absorbent backing. NRC rating with non-woven acoustic infill is shown as NRC. NRC rating with non-woven acoustic infill and 1"– 1.5" PCF Polywrapped Fiberglass is shown as NRC+PF.

Pattern	Dia	Cen	Deg	% Open	NRC	NRC+PF
A	0.059	0.157	60	12.81	0.75	0.85
B	0.059	0.157	0	11.09	0.75	0.85
C	0.059	0.314	60	3.20	0.65	0.75
D	0.059	0.314	0	2.77	0.65	0.75
E	0.059	0.628	0	0.69	0.60	0.70
F	0.059	0.628	60	0.80	0.60	0.70
G	0.063	0.1563	60	14.73	0.75	0.85
H	0.063	0.1563	0	12.76	0.75	0.85
I	0.063	0.3125	60	3.69	0.65	0.75
J	0.063	0.3125	0	3.19	0.65	0.75
K	0.063	0.625	60	0.92	0.60	0.70
L	0.063	0.625	0	0.80	0.60	0.70
M	0.098	0.217	0	16.02	0.75	0.85
N	0.098	0.4331	0	4.02	0.65	0.75
O	0.102	0.3937	0	5.27	0.65	0.75
P	0.102	0.3937	60	6.09	0.70	0.70
Q	0.125	0.25	60	22.67	0.80	0.90

Pattern	Dia	Cen	Deg	% Open	NRC	NRC+PF
R	0.125	0.25	0	19.64	0.75	0.90
S	0.125	0.500	45	10.08	0.65	0.85
T	0.125	0.375	0	8.73	0.70	0.75
U	0.125	0.5	60	5.67	0.70	0.75
V	0.125	0.5	0	4.91	0.65	0.75
W	0.136	0.379	0	10.11	0.75	0.85
X	0.136	0.379	60	11.68	0.75	0.85
Y	0.1875	0.25	60	51.01	0.90	0.95
Z	0.1875	0.25	0	44.18	0.90	0.95
AA	0.1875	0.375	0	19.64	0.75	0.90
BB	0.1875	0.5	0	11.04	0.65	0.95
CC	0.1875	0.5	60	12.75	0.75	0.85
DD	0.25	0.3438	60	47.95	0.90	0.95
EE	0.25	0.6876	0	10.38	0.75	0.85
FF	0.375	0.625	0	28.27	0.80	0.90
GG	0.375	0.625	60	32.65	0.80	0.90
HH	0.375	0.875	60	16.66	0.75	0.85

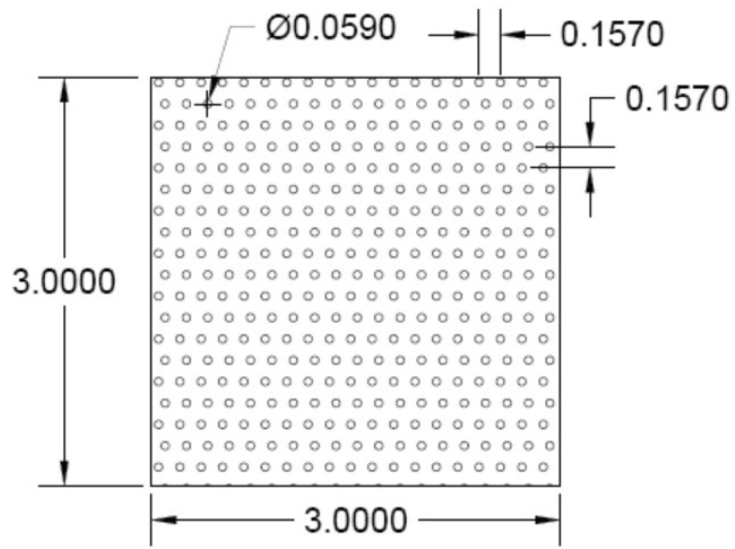

**PATTERN A**  
 0.059" DIA Holes x 0.157" (4mm) Spacing  
 60 Degree Staggered Centers

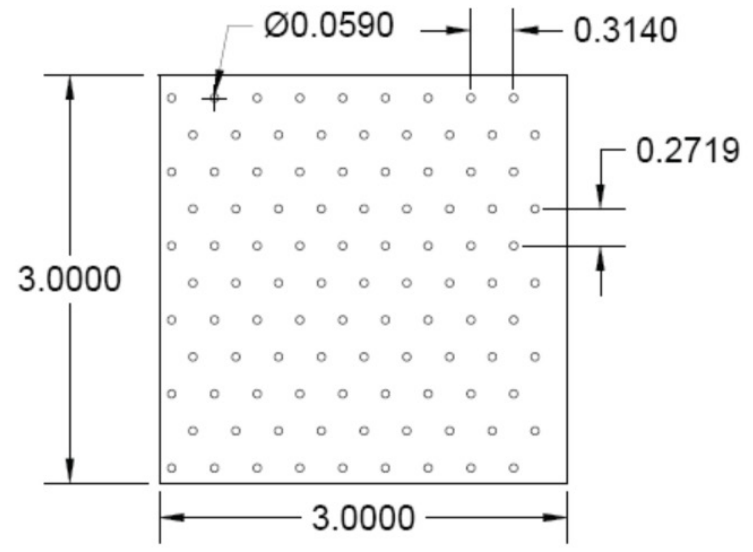

**PATTERN C**  
 0.059" DIA Holes x 0.314" (8mm) Spacing  
 60 Degree Staggered Centers

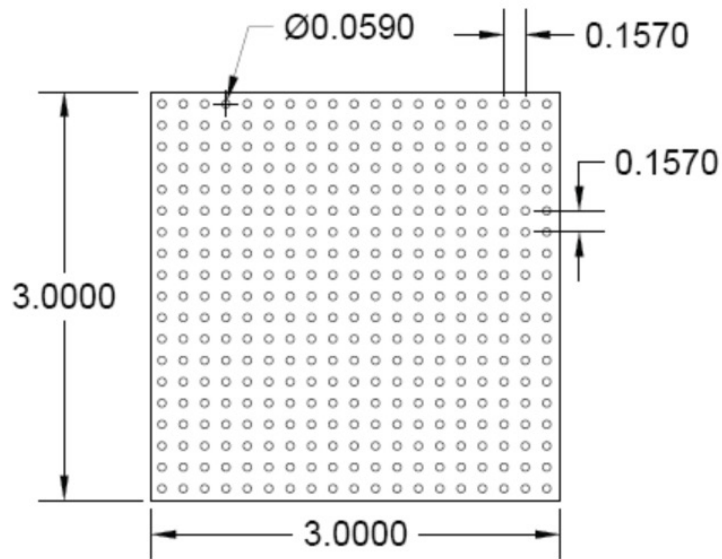

**PATTERN B**  
 0.059" DIA Holes x 0.157" (4mm) Spacing  
 Straight Centers

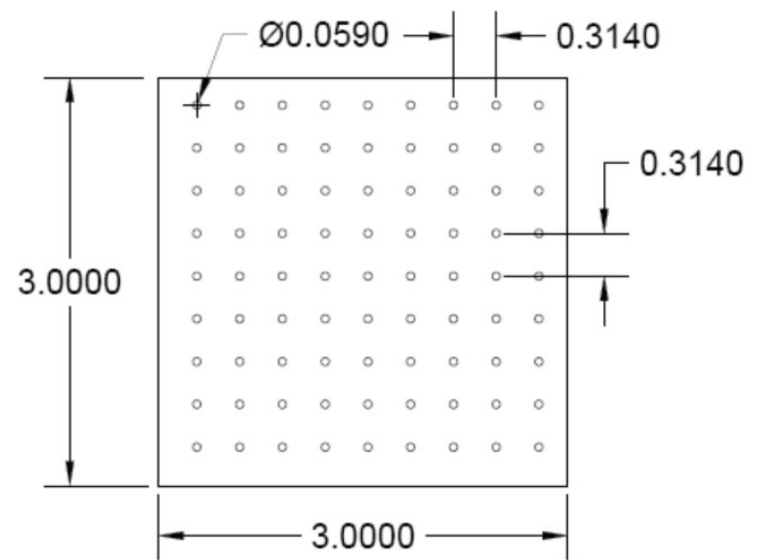

**PATTERN D**  
 0.059" DIA Holes x 0.314" (8mm) Spacing  
 Straight Centers

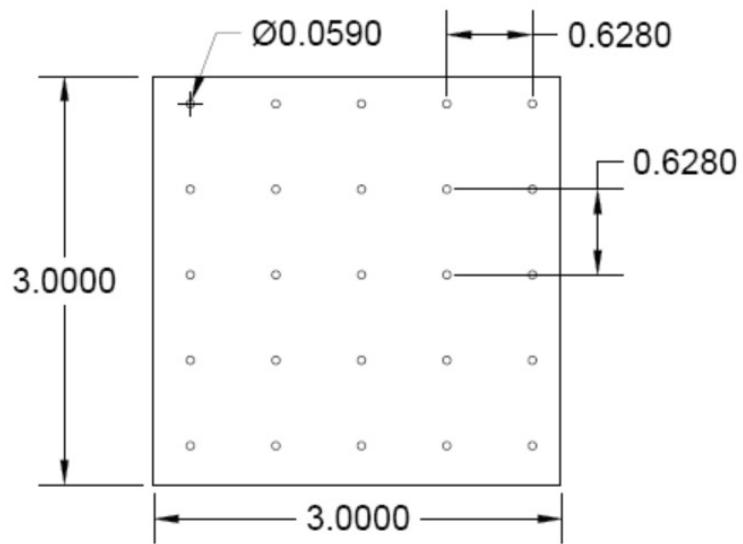

PATTERN E  
0.059" DIA Holes x 0.628" Spacing  
Straight Centers

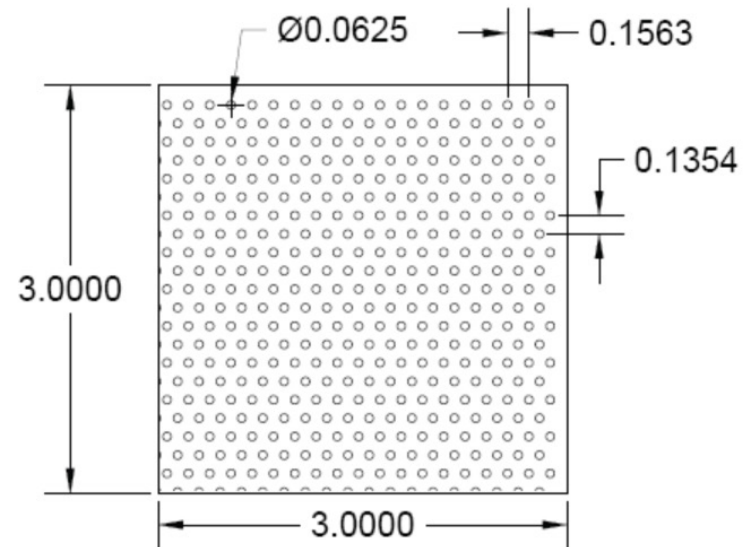

PATTERN G  
0.063" DIA Holes x 0.1563" Spacing  
60 Degree Staggered Centers

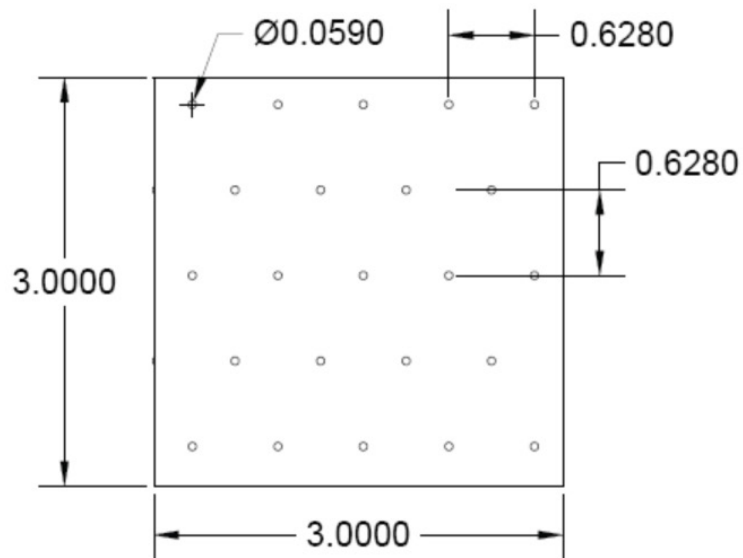

PATTERN F  
0.059" DIA Holes x 0.628" Spacing  
Staggered Centers

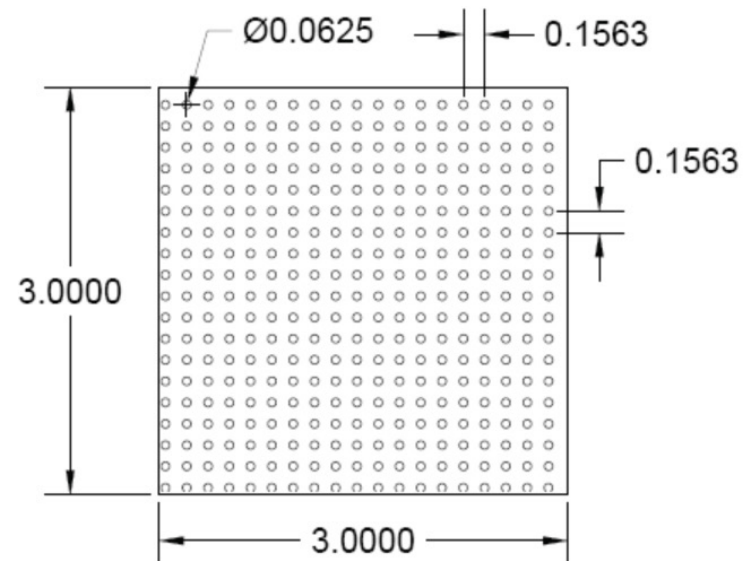

PATTERN H  
0.063" DIA Holes x 0.1563" Spacing  
Straight Centers

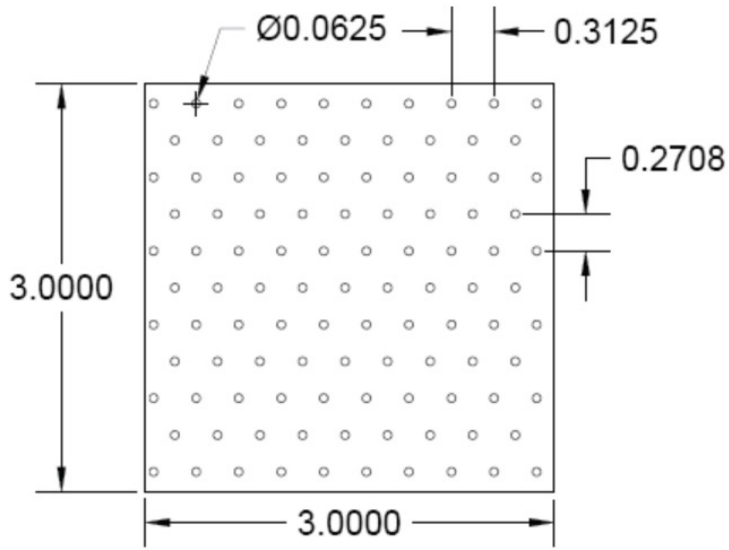

PATTERN I  
0.063" DIA Holes x 0.3125" Spacing  
60 Degree Staggered Centers

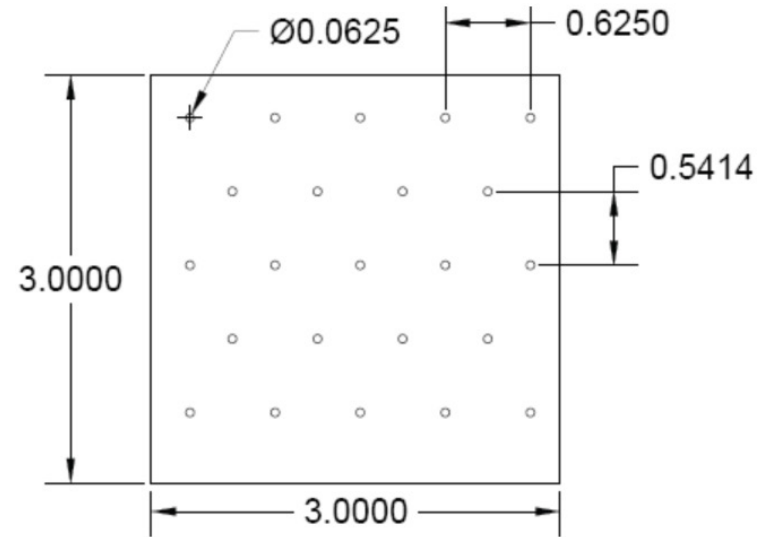

PATTERN K  
0.063" DIA Holes x 0.625" Spacing  
Staggered Centers

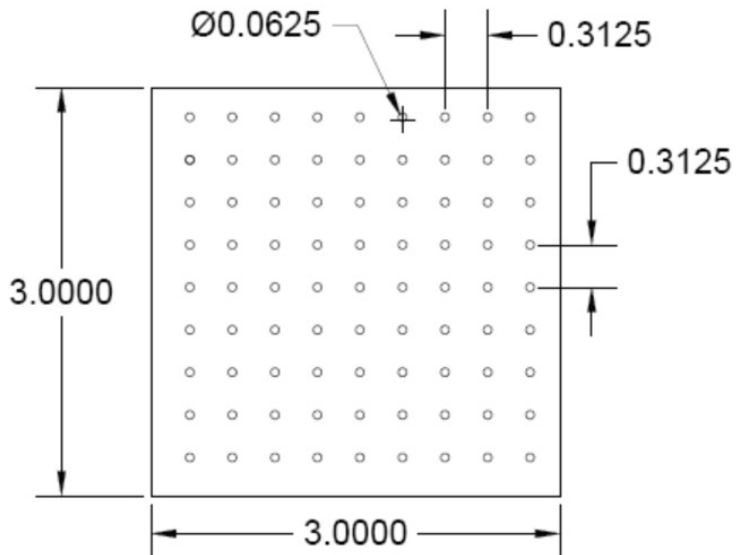

PATTERN J  
0.063" DIA Holes x 0.3125" Spacing  
Straight Centers

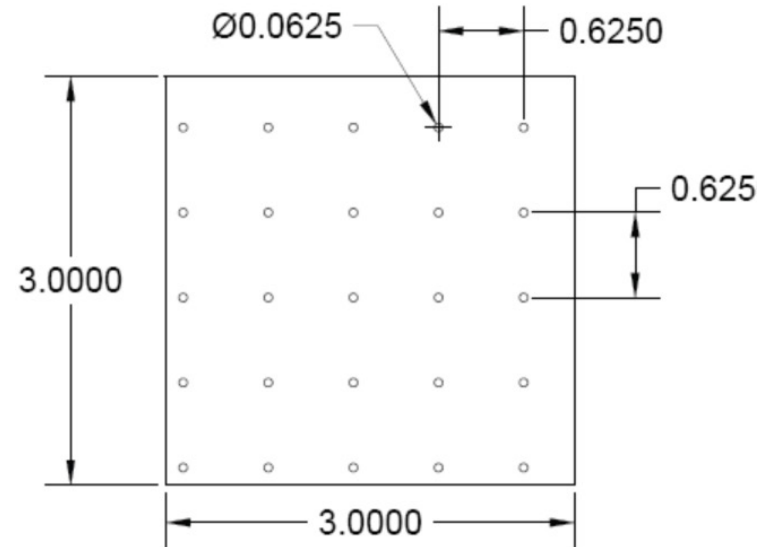

PATTERN L  
0.063" DIA Holes x 0.625" Spacing  
Straight Centers

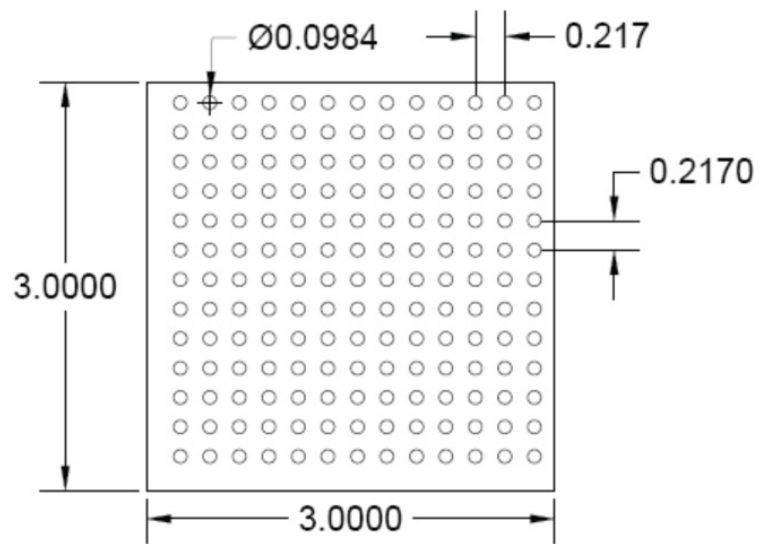

PATTERN M  
0.098" DIA Holes x 0.217" Spacing  
Straight Centers

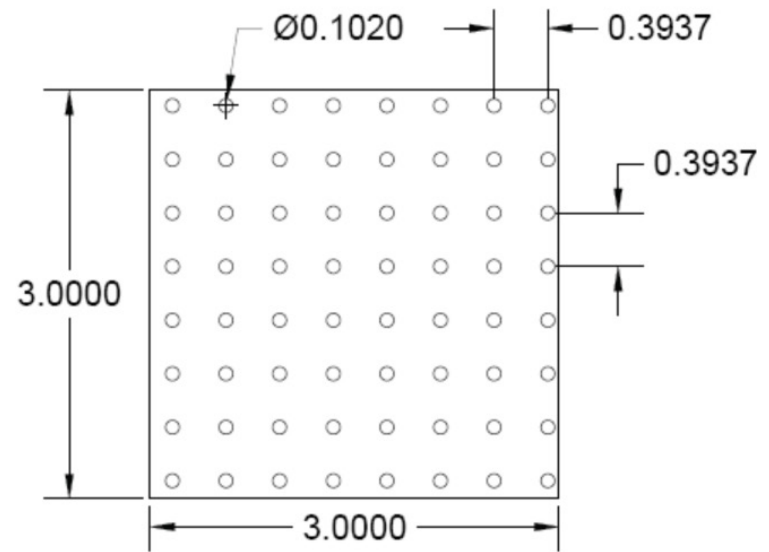

PATTERN O  
0.102" DIA Holes x 0.3937" Spacing  
Straight Centers

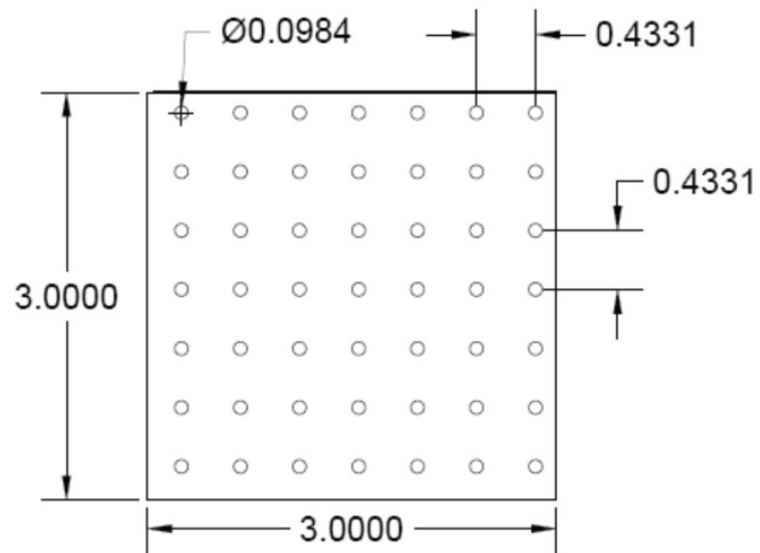

PATTERN N  
0.098" DIA Holes x 0.4331" Spacing  
Straight Centers

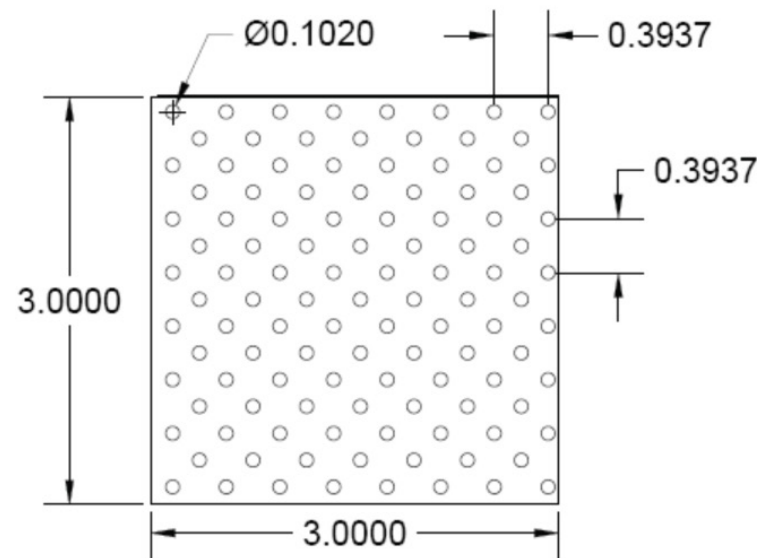

PATTERN P  
0.102" DIA Holes x 0.3937" Spacing  
Staggered Centers

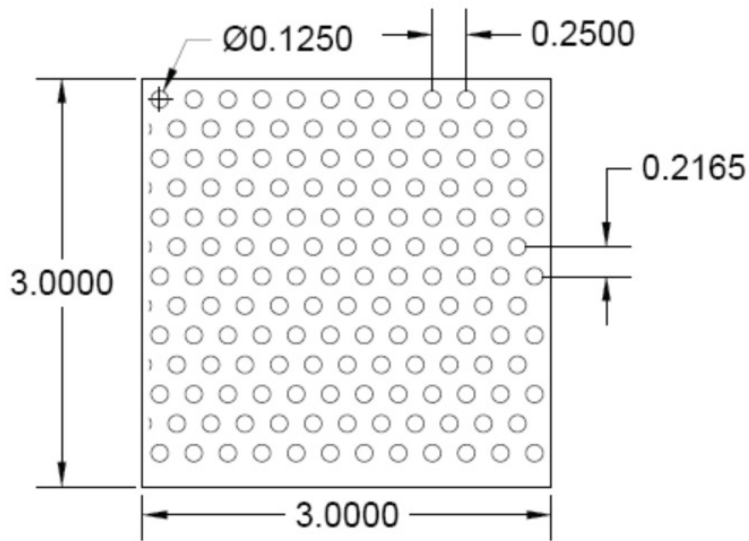

**PATTERN Q**  
 0.125" DIA Holes x 0.25" Spacing  
 60 Degree Staggered Centers

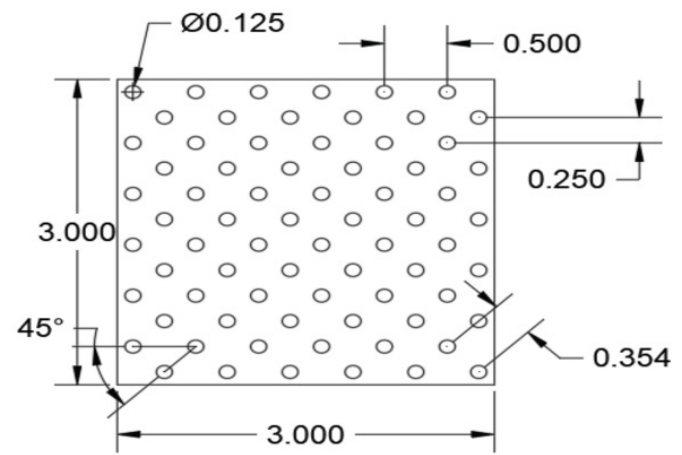

**PATTERN S**  
 0.125" DIA Holes x 0.500" Spacing  
 45 Degree Staggered Centers

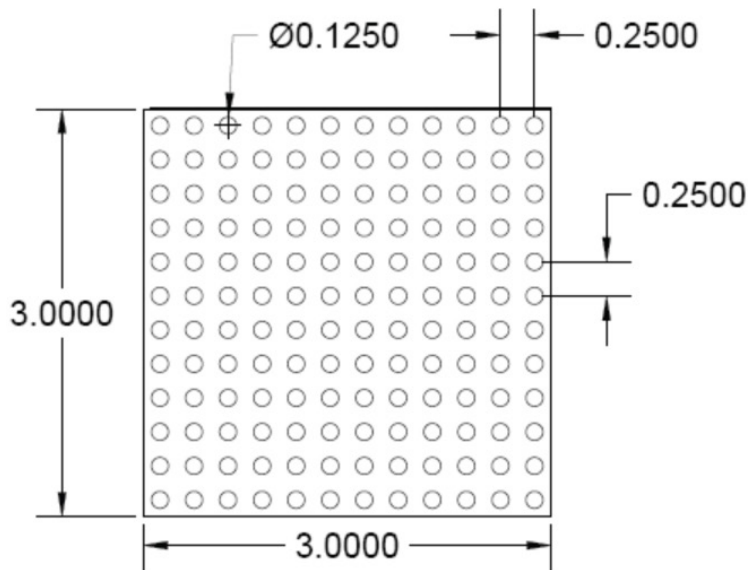

**PATTERN R**  
 0.125" DIA Holes x 0.25" Spacing  
 Straight Centers

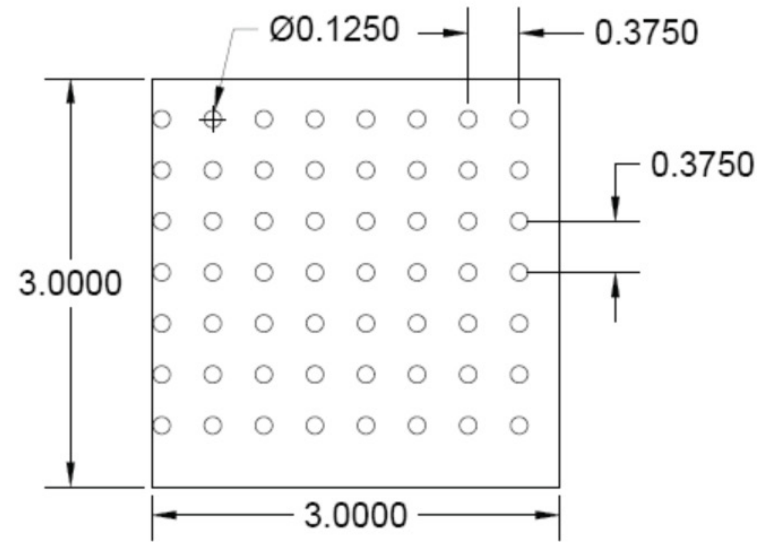

**PATTERN T**  
 0.125" DIA Holes x 0.375" Spacing  
 Straight Centers

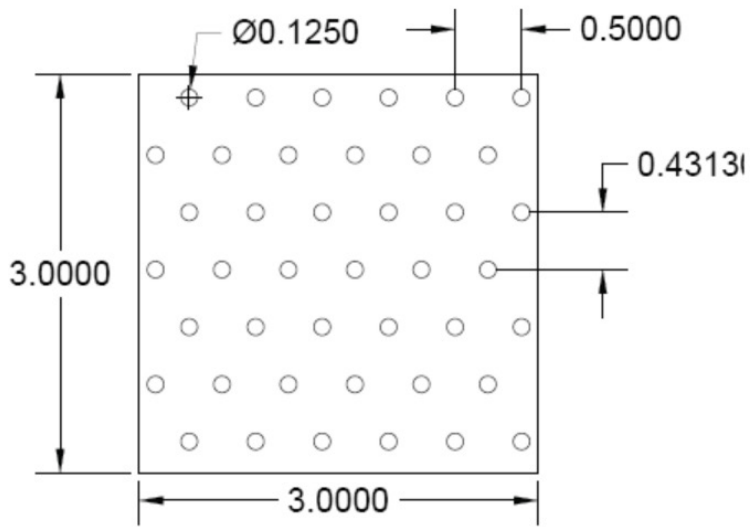

PATTERN U  
0.125" DIA Holes x 0.50" Spacing  
60 Degree Staggered Centers

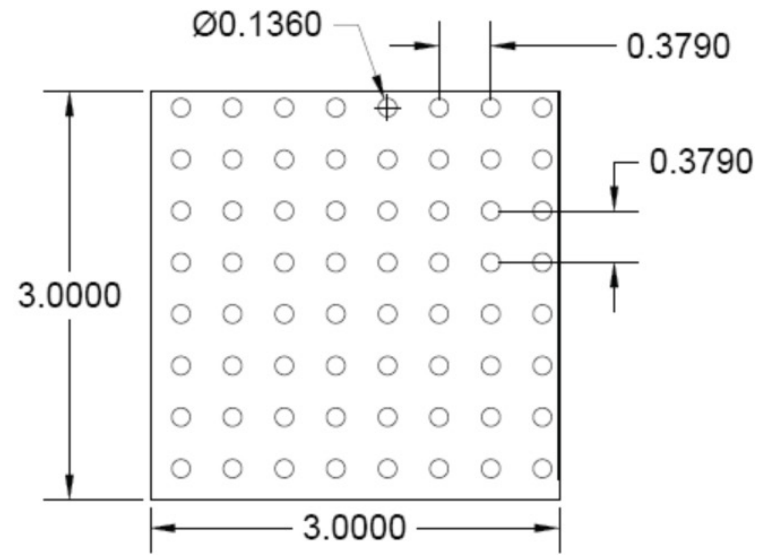

PATTERN W  
0.136" DIA Holes x 0.379" Spacing  
Straight Centers

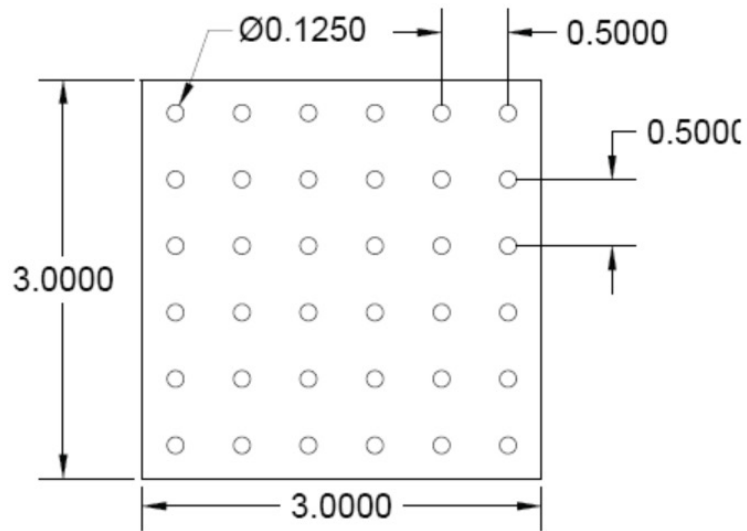

PATTERN V  
0.125" DIA Holes x 0.50" Spacing  
Straight Centers

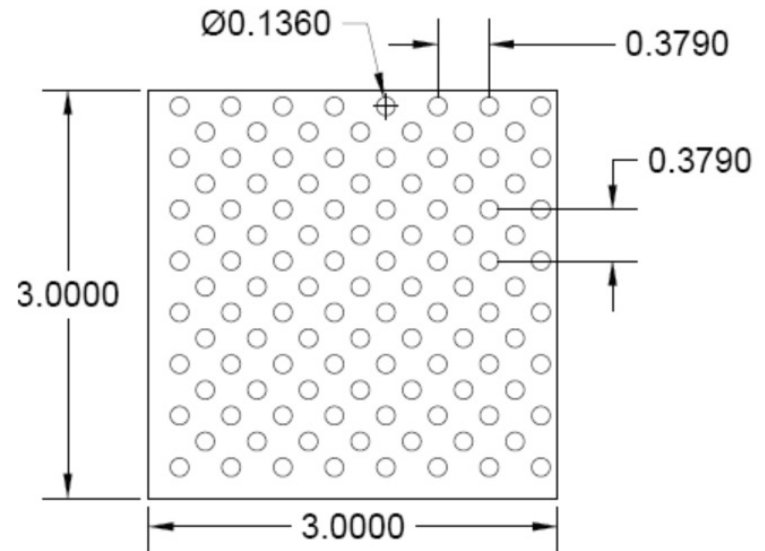

PATTERN X  
0.136" DIA Holes x 0.379" Spacing  
Staggered Centers

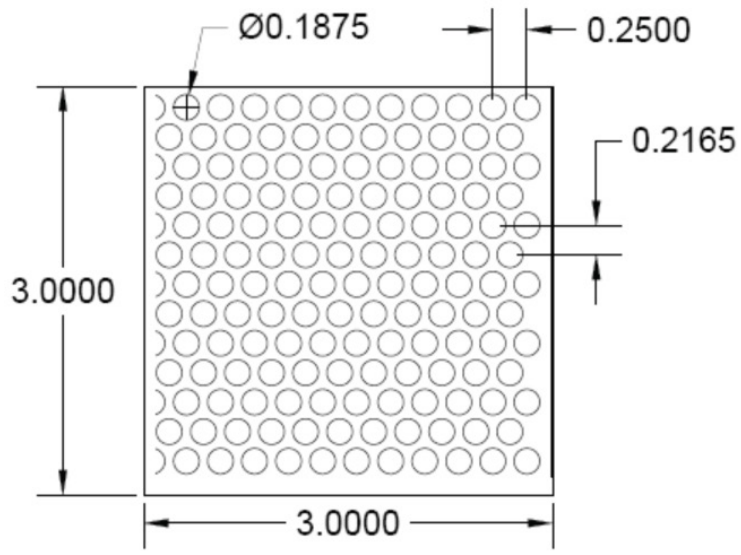

**PATTERN Y**  
 0.1875" DIA Holes x 0.25" Spacing  
 60 Degree Staggered Centers

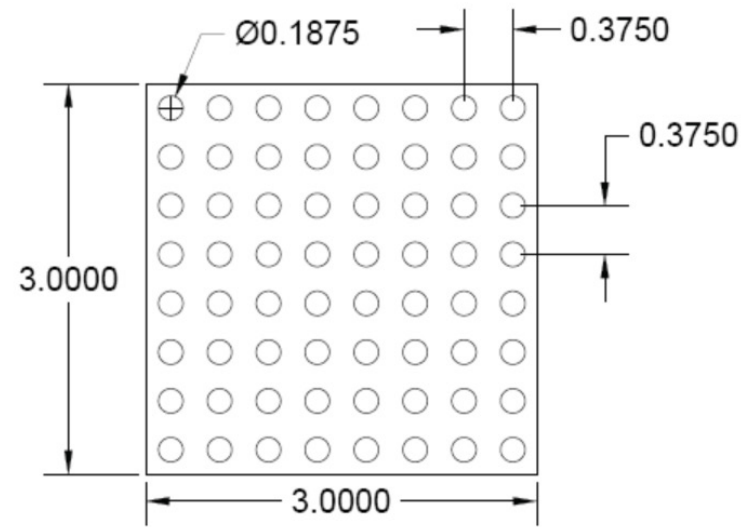

**PATTERN AA**  
 0.1875" DIA Holes x 0.375" Spacing  
 Straight Centers

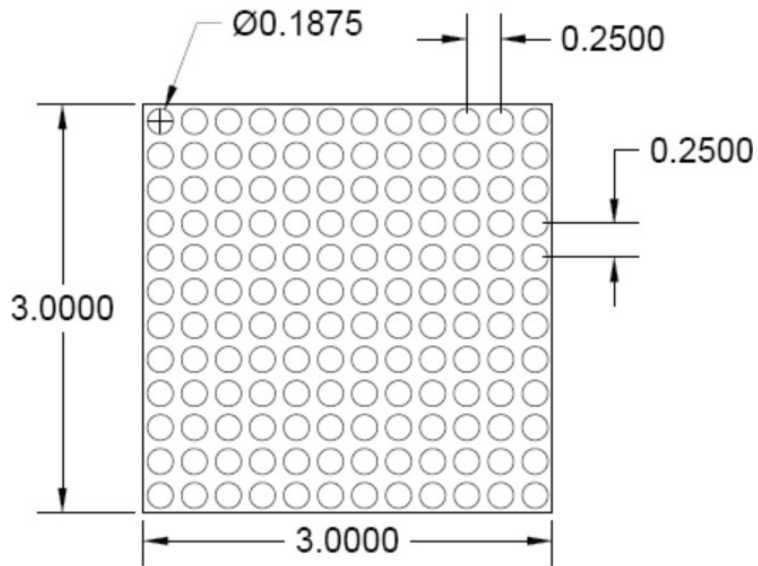

**PATTERN Z**  
 0.1875" DIA Holes x 0.25" Spacing  
 Straight Centers

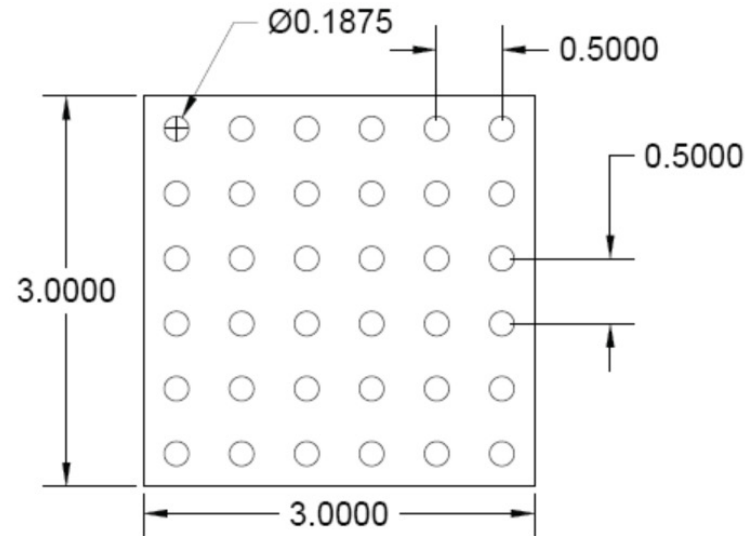

**PATTERN BB**  
 0.1875" DIA Holes x 0.50" Spacing  
 Straight Centers



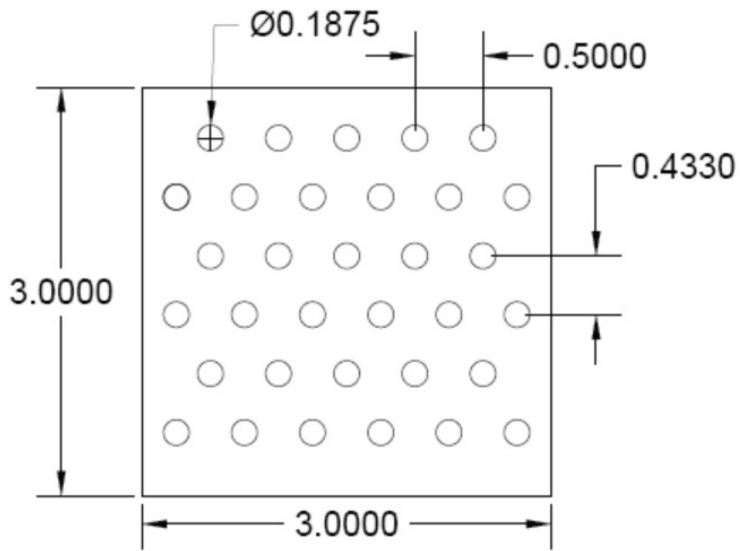

PATTERN CC  
0.1875" DIA Holes x 0.50" Spacing  
60 Degree Staggered Centers

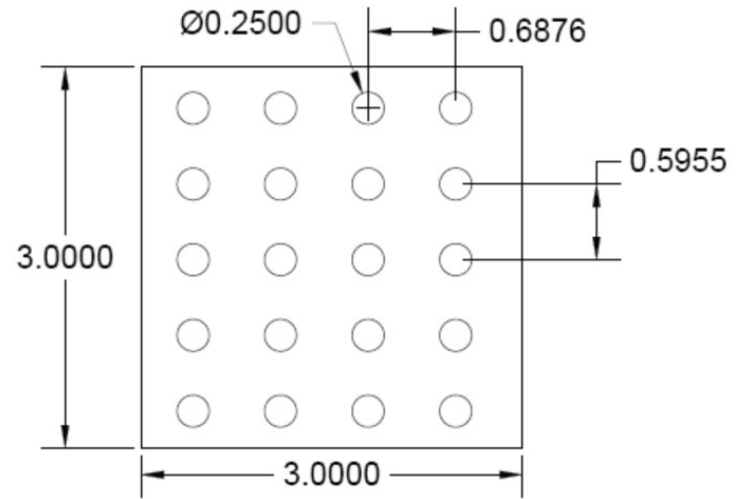

PATTERN EE  
0.25" DIA Holes x 0.596" Spacing  
Straight Centers

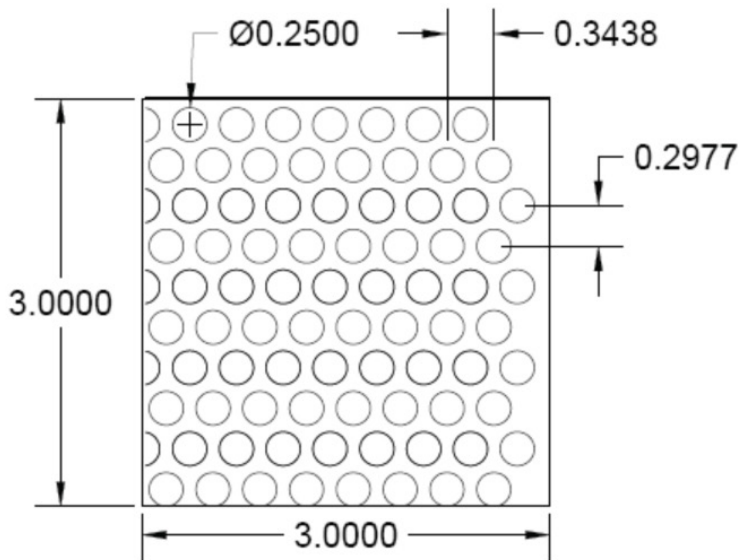

PATTERN DD  
0.25" DIA Holes x 0.348" Spacing  
60 Degree Staggered Centers

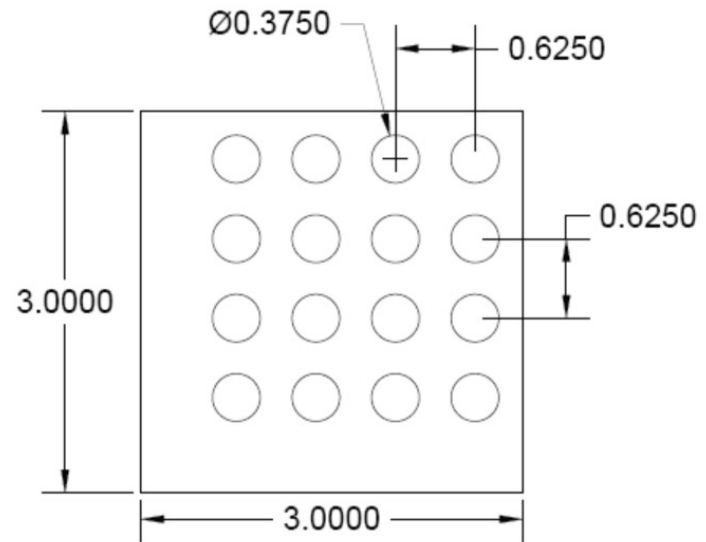

PATTERN FF  
0.375" DIA Holes x 0.625" Spacing  
Straight Centers

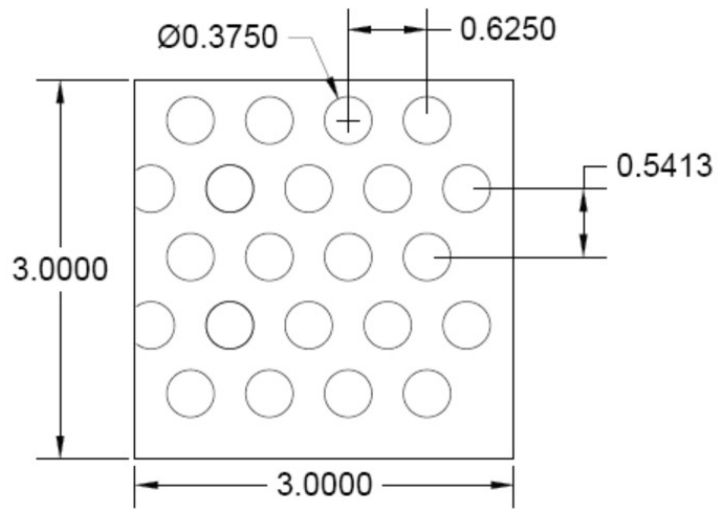

PATTERN GG  
 0.375" DIA Holes x 0.625" Spacing  
 60 Degree Staggered Centers

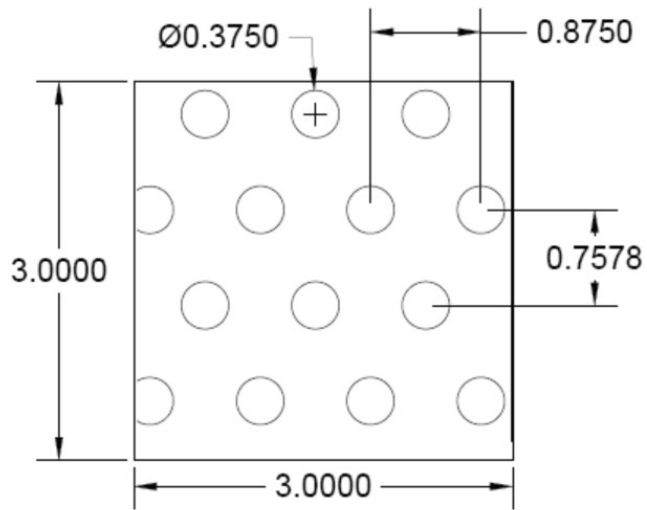

PATTERN HH  
 0.375" DIA Holes x 0.875" Spacing  
 Straight Centers